

➤ **Adapters to fit your Thule Child Carrier to your Bicycle**

12mm Thru-Axles

Internal Gear Hub Adapters

**Adapters for different shape frames
or bikes with integrated kickstands**

› Adapters to fit your Thule Child Carrier to your Bicycle

Your Thule Bicycle Trailer Kit attaches to your bicycle at the rear axle.

The method of attachment will depend on your bike:

1. 9mm Quick Release Skewers
2. Bikes with 12mm Thru-Axles
3. Bikes with internal gear hubs
4. Bike where the geometry of the bike frame makes it difficult to fit the Thule ezHitch cup

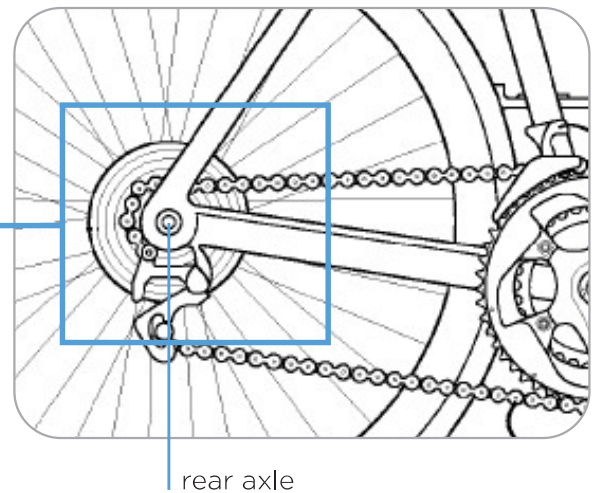

1. 5mm Quick Release Skewers

Most bicycles have a 5mm quick release (QR) through the rear axle. If your bike has either a QR like the one to the right or has no gears please follow the instructions that came with your bicycle trailer kit on how to attach the carrier to your bike.



The following bicycles will require additional adapters:

2. Bikes with 12mm Thru-Axles
3. Bikes with internal gear hubs
4. Bikes where the geometry of the bike frame makes it difficult to fit our hitch cup.

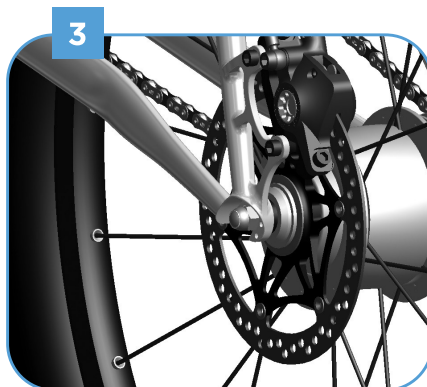

› 12mm Thru-Axles

To see which Thru-Axle fits your bike, please remove the Thru-Axle from your bike following the instructions that came with your bike.

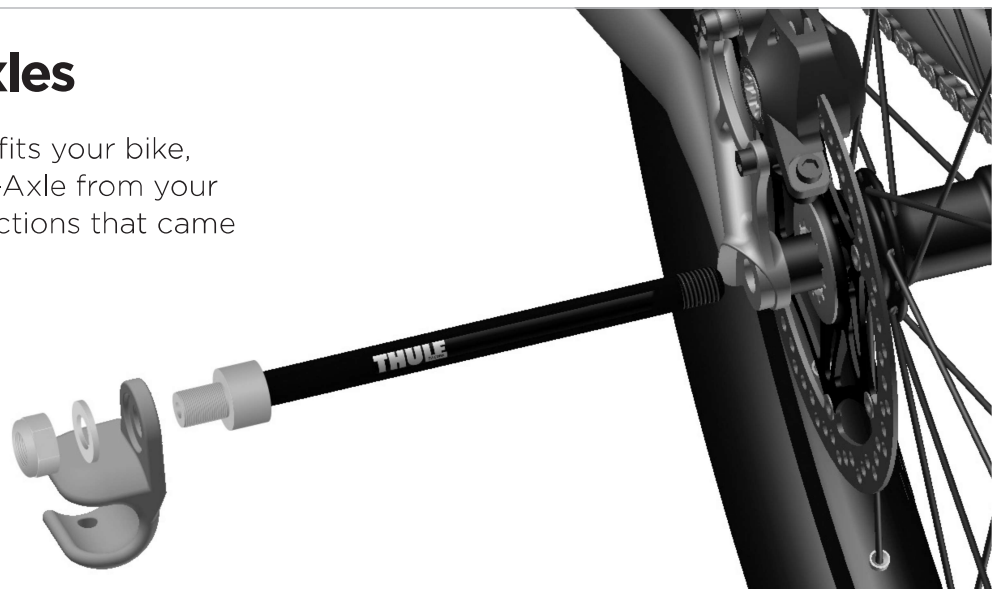

To choose the right thru axle, please refer to the guide on the Thru-Axle product pages on [thule.com](https://www.thule.com).

› Internal Gear Hub Adapters



Internal Hub Hitch Adapter Shimano, 3/8" x 26 (part# 20100797)

Below are examples of 3/8 hubs that require the Internal Hub Hitch Adapter Shimano:

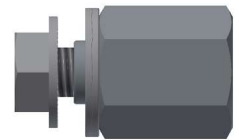

Brand	Model	Shimano Part #	Description
Shimano	Nexus	FH-IM37	Roller Brake Hub
		SG-3C41	3-Speed Internal Gear Hub w/ Coaster Brake
		SG-3D55	3-Speed Internal Gear Hub
		SG-3R40	3-Speed Internal Gear Hub w/ Roller Brake
		SG-7R46	7-Speed Internal Gear Hub w/ Roller Brake
		SG-8R56	8-Speed Internal Gear Hub
		SG-8C31	8-Speed Internal Gear Hub w/ Roller Brake
		SG-8R36	8-Speed Internal Gear Hub
	Alfine	SG-S500	8-Speed Internal Gear Hub
		SG-S501	8-Speed Internal Gear Hub
		SG-S505	8-Speed Internal Gear Hub / Disc Brake
		SG-S700	11-Speed Internal Gear Hub
		SG-S705	11-Speed Internal Gear Hub / Disc Brake
	Coasting	SG-3C01	Automatic Shifting Internal Hub Gear

Internal Hub Hitch Adapter SRAM, M10x1.0
(part# 20100798)

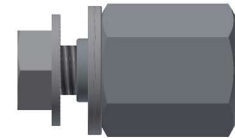

Below are examples of 10 mm hub axles that require the Internal Hub Hitch Adapter SRAM:

Brand	Model	Description
SRAM	DD3-30/-27/-24	Internal Gear Hub w/ Cassette
	I-Motion 9	9-Speed Internal Gear Hub
	G8	8-Speed Internal Gear Hub
	I-Motion 3	3-Speed Internal Gear Hub
	Torpedo	Single Speed Fixed/Free
Shimano	Nexave IF-C530	Inter-3 Freehub (3x8)
	Nexave FH-C810	Freehub Dynamo w/ 8-Speed Internal
	Nexave FH-IM70	Freehub for 8/9 Speed Cassette
	Nexave FH-IM50	Freehub for 8-Speed Cassette
Surly	Track and Flip-flop Hubs	
Rohloff	Speedhub 500/14	14-Speed Internal Gear Hub
NuVinci	N360	Continuously Variable Transmission (CVT)
BionX	P500	Electric Hub Motor
	P250	Electric Hub Motor
	P200	Electric Hub Motor

Internal Hub Hitch Adapter SRAM SPECTRO, FG 10.5x1.0
(part# 20110722)



Below are examples of 10,5 mm hub axles that require the Internal Hub Hitch Adapter SRAM SPECTRO:

Brand	Model	Description
SRAM	Spectro S7	7-Speed Internal Gear Hub
	Spectro P5	5-Speed Internal Gear Hub
	Spectro T3	3-Speed Internal Gear Hub
	Spectro 3x7	Internal Gear Hub w/ Cassette
	DualDrive	Internal Gear Hub w/ Cassette
	Sparc	Electric Hub Motor

› **Adapters for different shape frames or bikes with integrated kickstands:**

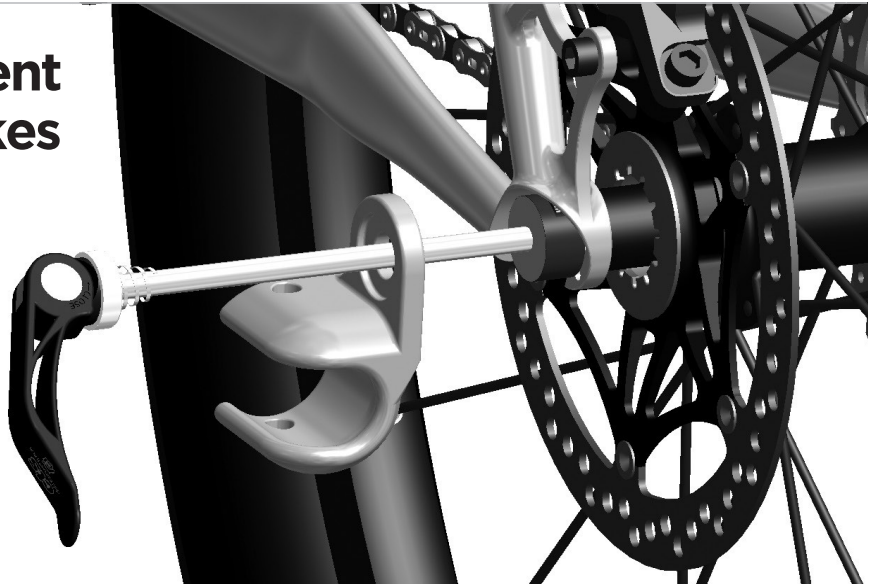

Drop Out spacer 10mm
(part# 20110723)

Intended for bicycles with hooded drop outs

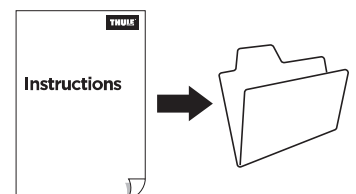

 Thule Sweden AB, Borggatan 5
335 73 Hillerstorp, SWEDEN

› PART OF THULE GROUP

 info@thule.com

 www.thule.com

© Thule Group 2021 All rights reserved.